

Development of Autonomous Demand Response System for Electric Load Management

Yusak Tanoto, *IEEE Member*

Centre on Sustainable Energy Studies
Petra Christian University
Surabaya, Indonesia
tanyusak@petra.ac.id

Djoni Haryadi Setiabudi, *IEEE Member*

Informatics Department
Petra Christian University
Surabaya, Indonesia
djonih@petra.ac.id

Abstract—This paper presents a proposed framework for developing a device in which allowing users to autonomously manage electricity load demand through monitoring, controlling and scheduling mechanism. The proposed framework utilizes the principle of Demand Side Management in order to save energy by monitoring and re-arranging appliances load curve, of which resulted by either individual load or the whole loads in their premises. The system is comprised of the load metering, minimum system as controller, and wireless communication. The accessibility of the system is improved by the inclusion of the Internet of Things platform.

Keywords—Demand response; load monitoring; controlling; scheduling; artificial intelligent

I. INTRODUCTION

Demand response (DR) in principle is a mechanism which allows electricity customers manage the time of use of their appliances in order to response price changes. Nowadays, in developed countries, demand response mechanism is quite a common implementation. While the supporting technologies and infrastructures are under progressive development, the combination of DR mechanism with smart grid framework is possible. Although the implementation of DR along with its various mechanisms is quite common in the developed countries in which practicing deregulated power sector policy, it is not the same case for the developing countries. Under the conventional power sector regulation, active participation of the electricity customers is very low in the developing countries. Nevertheless, many people are now having access to modern communication devices as well as increasing their awareness of how to implement energy efficiency and conservation. This paper presents brief overview on the several available framework of demand response mechanism which are either proposed or implemented in the electricity network using sophisticated technology environment. In addition, this paper also present a proposed framework with the use of technology that allows electricity users manage their daily demand pattern autonomously using the Internet of Things approach. The loading management includes monitoring, controlling, and scheduling any particular appliance and their load system.

This paper is organized as follows; overview of the several aspects of DR programs are discussed in the next section, followed by the overview of the proposed framework and the

device, then after initial testing results of the device is presented subsequently. Finally, the conclusion is provided at the end of this paper.

II. DEMAND RESPONSE PROGRAMS

A. Demand Response Scheme

In general, DR scheme can be classified into two broad categories: incentive-based scheme and price-based scheme [1]. According to other study, the two categories have other name and distinct programs, i.e. dispatchable or incentive-based programs, and non-dispatchable or time-based programs, respectively [2]. In the incentive-based scheme, energy consumption in the customers premises is reduced according to sort of contractual agreement between customer and utility company. Meanwhile, the price-based scheme accommodates different cost of electricity over predetermined time period of energy consumption. Classification of DR scheme is presented in Table 1 [3, 4, 5].

TABLE I. DEMAND RESPONSE SCHEME

DR Scheme	Examples of Programs	DR Scheme	Examples of Programs
Incentive-based	Direct Load Control	Price-based	Time-of-Use
	Interruptible Service		Critical Peak Pricing
	Demand Bidding		Critical Peak Pricing with Control
	Capacity Market Program		Peak Time Rebate
	Non-Spinning Reserve		Real-Time Pricing
	Regulation Service		System Peak Response Transmission Tariff
	Spinning Reserve		

According to the scheme, incentive-based programs allow utility side, up to some extent, to directly control, schedule, and even disconnect loads in order to execute the programs. On the other hand, customers are individually managed their energy consumption by either reducing or shifting from peak to off-peak period in the price-based scheme. In addition, the price of electricity may differ and dynamically changes at day

to year time frame. In further, comparison of DR programs include the scheme type, rule, situation, rate type, activation period, response type, advantages and disadvantages of the programs is presented by Haider et.al. [6]. Although DR programs are designed to offer benefits for both utility and customers by saving energy and cost, in fact, potential challenges and possible drawbacks from implementing any of these two schemes are still existed. Challenges may occurred in terms of establishing an optimal DR system along with appropriate strategy to match the re-arrange load with available supply [7]. Drawbacks may exist due to lack of privacy experienced by customers in the case of incentive-based scheme [8] and approaches to determine price rate over various level of energy consumption in the case of price-based programs [9].

The pricing strategies of some DR programs as part of residential customer responsiveness is presented in Figure 1 [10]. Other literature include study of the effect of different tariffs on customer responsiveness [11, 12].

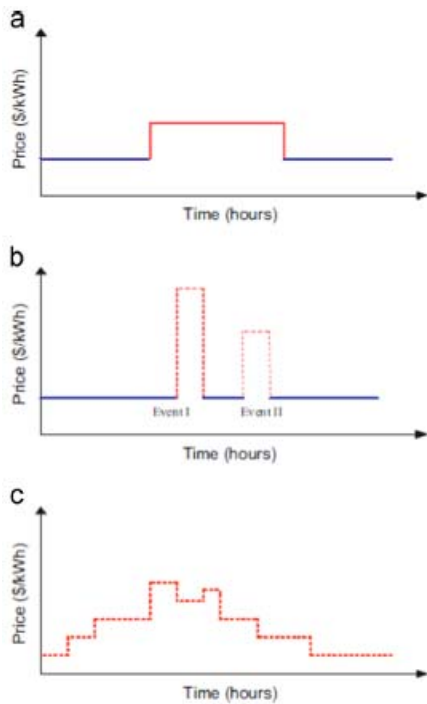

Fig. 1. The pricing strategies for DR schemes (a) Time-of-Use (ToU), (b) Critical Peak Pricing and (c) Real Time Pricing [10]

In Figure 1 (a), the load can be shifted with minimum cost due to low price rate during off peak. However, only one single price rate is applied for all consumption level. In Figure 1 (b), utility offers discount rate in a short time period. On the other hand, customer should lessen or shift their resource for particular period. Lastly, the real time pricing strategy enables customer to reduce the electricity cost towards periodical price change by quick responding to the situation, as seen in Figure 1 (c). Nevertheless, many customers do not have opportunity to participate in these kind of schemes.

In addition to most DR scheme, Haider et.al. [6] proposed adaptive consumption-level pricing scheme (ACLPS) in order to include external effect due to increase in customer demand. The scheme is based on two factors, i.e. adaptive pricing and customer allowance. The proposed scheme is presented in Figure 2.

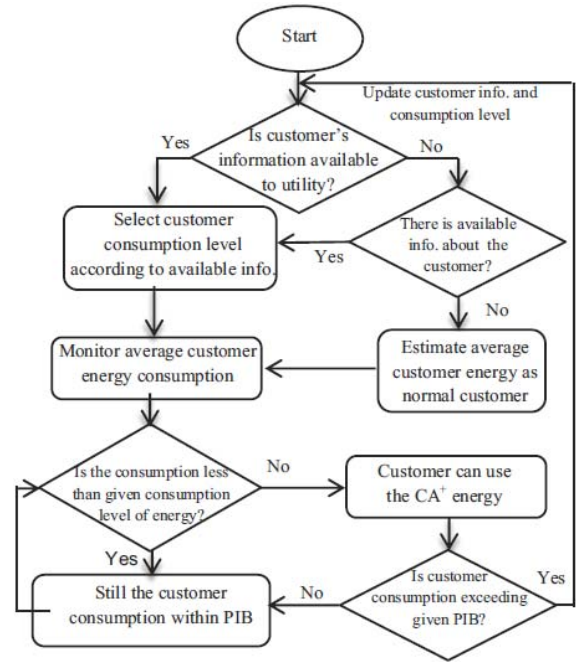

Fig. 2. The flowchart of the proposed load management strategies [6]

B. Demand Response in Smart Grid Environment

Illustration of general smart grid infrastructure, as part of electricity network is presented in Figure 2.

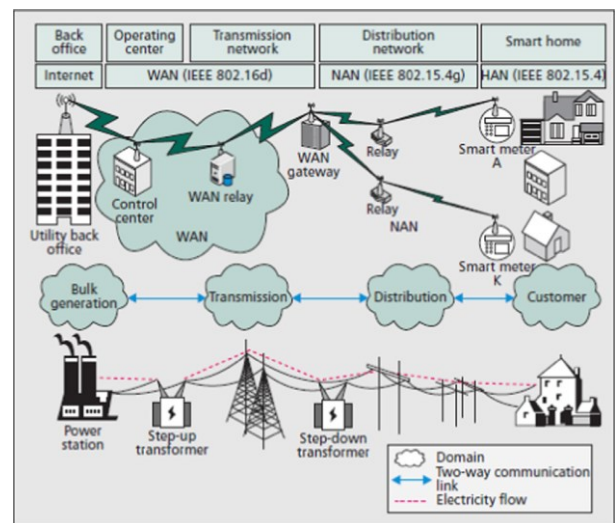

Fig. 3. Example of smart grid communication infrastructure [14]

As can be seen in Figure 3, recent infrastructure development in terms of smart grid environment create a platform for developing advance and reliable DR schemes. The signal of DR may use two way communication between utility and customer which allow the monitoring of DR schemes update [13]. However, the complexity of the network configuration leads to difficulty in choosing the appropriate communication network due to many specific requirements of the connection [15].

C. The Role of Internet of Things

A frontier of information and communication technologies is The internet of things (IoT). IoT is the new technology that make embedded objects belong to the internet in an interactive way [6]. Through IoT, digital and physical entities can be linked using appropriate information and communication technologies [16]. Another definition of IoT is explaining the network of physical devices, vehicles, buildings and other items, embedded with electronics, software, sensors, actuators, and network connectivity that enable these objects to collect and exchange data. The goal of the Internet of Things is to enable things to be connected anytime, anyplace, with anything and anyone ideally using any path/network and any service [17].

Implementation of IoT will transform the traditional power system into a networked Smart Grid that is automated and enriched by larger operating and monitoring capability. Therefore, integration and interfacing of the power grid into the Internet, involving generation, transmission, metering and billing, diagnostics, and many more aspects.

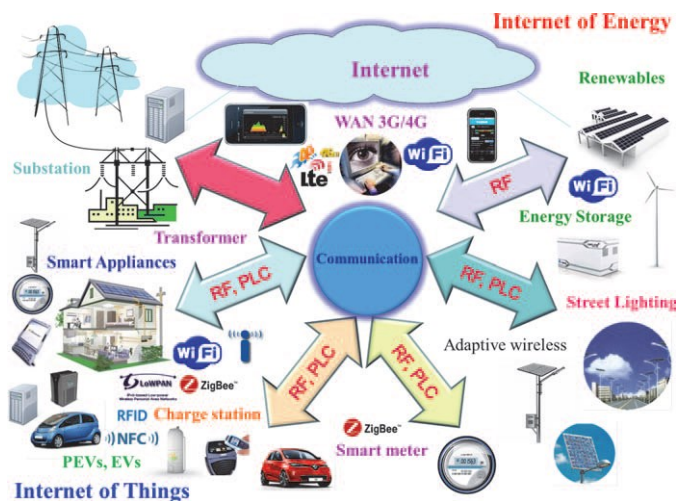

Fig. 4. Internet of Things embedded in internet of energy applications [17]

The IoT would enable the ability to produce, store and efficiently use energy, while balancing the supply/demand by using a cognitive Internet of Energy that harmonizes the energy grid by processing the data, information and knowledge via the Internet [17]. Some research already done on IoT for DSM.

Rainforest Automation, an energy management technology developer, has launched a new range of products and services that make use of the IoT and industry standard protocols to provide a solution that brings together resources from widely distributed homes and small businesses. Rainforest’s portfolio is targeted at utilities that are looking to deploy DR for their residential and small commercial customers [18].

Other applications of IoT in DR can be found in several projects [19-23]. IoT technologies is used to manage energy consumption by utilizing open source protocols, such as ZigBee, IP, and IETF protocols [19]. Remote management and control of domestic devices are the basic function of a condition monitoring and in-home energy management. The main function is to reschedules the inhabitant operating time [20]. A set of network technology is proposed as a heterogeneous meter network which connect a web based smart metering application. The application is suitable to any IP-based physical technology. The approach can be used to conduct monitoring, analysis and power consumption [21]. A web of things application to manage in-home load consumption is developed using a web browser where customer can monitor and schedule the load according to the available local energy [22]. Another low-cost in-home load management system is developed using the connection with the social network Twitter. Both wireless and wire connection are available so that customer can schedule the appliances remotely [23].

D. Python Programming Language

Python is an open source multiplatform language interpreted within strong dynamic typing and rich standard library. Dynamic typing can adapt to execution [24]. Python is a multi-paradigm language. In particular, it allows procedural and object oriented programming. It supports introspection, allowing for example dynamically consultation of the composition of a class, an object or a code file. The well-known Raspberry Pi board is used as platform to exploit the different proposed concepts. Python-based open-source libraries for scientific computing and graphical representation are used to perform Matlab-like simulations and to implement classical control loops [25]. The Python interpreter and the extensive standard library are available in source or binary form without charge for all major platforms. Python can play a great role in IoT applications for reasons like: IoT involves a lot of data analytics and python has got rich modules e.g. NumPy, pandas, matplotlib, ipython, sci-py etc for all such purposes, Raspberry pi "becoming famous as IOT DIY platform" has a great support for python libraries like Rpi GPIO [26].

E. MySql Database

MySQL is developed by MySQL AB, Sweden. It is released under an open-source license. MySQL is very powerful program as it handles a large subset of the functionality of the most expensive and powerful database packages. MySQL works on many operating systems and with many languages including PHP, PERL, C, C++, JAVA.

MySQL works very quickly and works well even with large data sets and is very friendly to PHP for web development, also supports large databases. Although the default file size limit for a table is 4GB, it can be increased to a theoretical limit of 8 million terabytes.

III. A PROPOSED FRAMEWORK FOR DEMAND RESPONSE SYSTEM

In this study, an autonomous demand response system is developed to monitor and manage domestic load demand. Unlike the common DR mechanism which allow communication between user and utility, the developed system is intended to be implemented in the environment which is not supported by DR infrastructure. In many developing countries, like Indonesia, DR mechanism is not implemented yet. Hence, energy efficiency still rely on few “unofficial”, basic DSM activities, for example by installing energy efficient lamp.

Typical DR scheme which allow communication between electricity customers and utility still not possible due to two things. Firstly, the absence of DR technologies and poor data infrastructure, and secondly regarding the unsupported regulation. On the other hand, electricity price continuous to increase. To response this situation, a device named autonomous demand response system is developed in this research. To be installed in the customer side, the main purpose of developing such system is to enable users, to monitor, analyze, and manage electricity consumption independently. This will lead the utilization of energy towards an efficient stage regardless the absence of supporting regulation and sufficient data communication technologies between utility and users. Figure 5 depicts the framework.

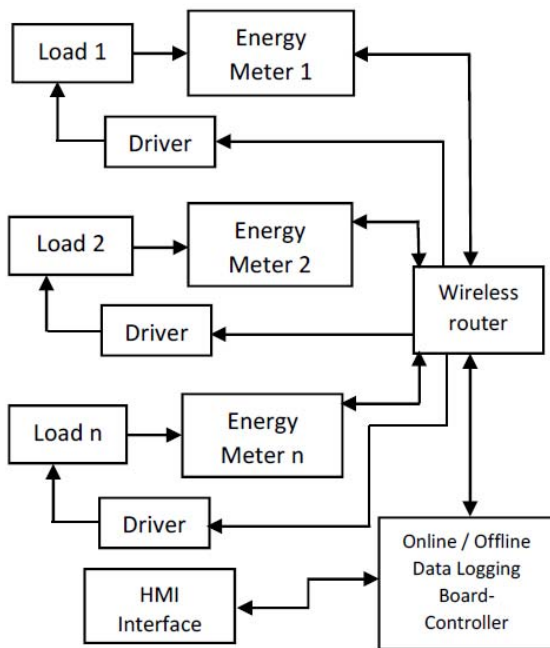

Fig. 5 Framework of the proposed autonomous DR system

The proposed framework of the autonomous DR system is based on simple communication technologies which involve of monitoring, processing, data logging, and enhanced with wireless data communication and IoT utilization. The system is designed with a simple working mechanism. Electricity data such as power, voltage, current, power factor, and others is measured and logged in a mini PC through the Ethernet network and wireless data connection. User can control their load pattern by inputting certain constraints as response to the recorded load pattern. This is allowing the device, for example, to schedule appliances activation. The “active” mechanism would also enable system to automatically find the optimum loading pattern.

There are three development phases of this project. The first phase is to develop a system which able to monitor the energy consumption parameters of individual of group of individual loads, for example water pump, lamps, Air Conditioner, washing machine, etc. Monitored load data is transferred wireless and are collected periodically in a wireless-data logging device, in the same time act as a controller. A computer connected to the data logging is used as the HMI to manage and control system. Load curve for whole loads or any individual load is the purpose of this stage. The second phase would encompass control mechanism to activate, switch on/off and to reschedule load(s) according to the DSM principles, and to plan for the optimum load curve in regards to some constraints. The DR system would be designed to be an “active” system, where the controlling mechanism will be executed right after it meets the constraints or predetermined conditions. Finally, the system would be connected into the IoT by adding the tablet PC to remotely control the system.

IV. RESULTS AND DISCUSSION

The developed system consists of three main functions, i.e. monitoring, controlling, and scheduling. In this paper, the first phase of the whole project is reported. This initial phase, as described in earlier section, is seen as an important part for the whole project because the accurate remote loading monitoring has to be established for either three phase or single phase load measurement. In addition, successful data measured duration in terms of its length as well as the recording time cycle, for example, every 5 second data collecting, are essential part to be ensured. In the proposed DR system, PM-1200 energy meter is connected via RS422/485 Ethernet converter into a wireless router. The wireless router is involved in the system to transfer the data to the Raspberry Pi3 board, which act as a controller as well as a data logger. The controller is programmed so that the data storage can be performed either in online or offline condition.

User interface of the DR system is a computer or a laptop which is connected to the Raspberry board. The interface is allowing user to input necessary key parameters, select measurement parameters, display the load curve and access data over several features. It has data logger, graphical display, data browser, holding register, configuration, control, and scheduling features. All features are accessible except

control function, which will be developed in the next phase. The proposed device allows users to easily track the electricity loading pattern for a whole system or for each appliance. This is because one power meter consists of three measurement terminal. If the load is a single phase system, hence each terminal of the meter is performed as a single phase meter. On the other hand, if the measured load is a three phase load, the measurement is in the three phase mode. The selected load parameters is logged in the MMC card inserted in the controller. The data is stored under MySQL platform whereas data communication is conducted using Python programming language.

In the proposed DR system, user can observe graph of selected load parameter over the predetermined time period. By inputting the start and end period, collected data can be searched, copied, and printed in the format of CSV, excel, or pdf, in the data browser feature, as presented in Figure 6. Meanwhile, screenshot of live graph-live data features is presented in Figure 7.

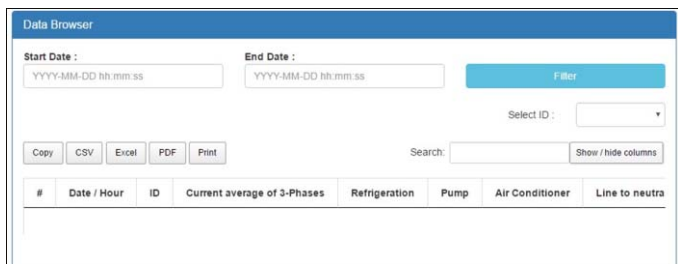

Fig. 6 Screenshot of the main features of the Autonomous DR system

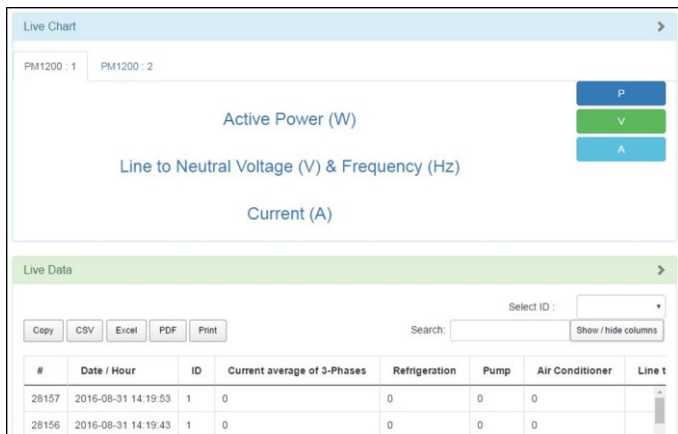

Fig. 7 Screenshot of the live graph-live data section

In this paper, remote monitoring of three-single phase air conditioners energy consumption over a certain period is presented. Active power as well as current and voltage of each air conditioner are measured. Active power-live graph for each air conditioner, two-2 HP and one-1 HP rated power, is presented in Figure 8. Meanwhile, screenshot of live data that is stored in the data logger, is presented in Figure 9.

Trials have been conducted to test the response of the proposed system in terms of data communication and recording time as predetermined in the user interface. Remote monitoring function of the DR system has worked well, as the selected measurement data have been well transferred and logged into the Raspberry. Future work of this project will focus to improve user interface experience, in addition to the major work, which is utilizing the recorded data to control their future energy demand. Therefore, appropriate algorithm of controlling the load pattern as well as load duration are essential.

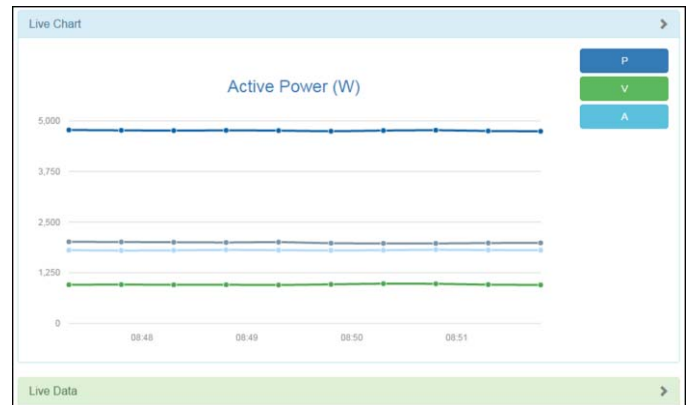

Fig. 8 Screenshot of active power-live graph for measured load

#	Active power, total	Active power, phase 1	Active power, phase 2	Active power, phase 3	Frequency, Hz
44936	4761.58	1974.44	980.403	1806.75	49.9664
44935	4745.05	1979.91	963.792	1801.35	49.9491
44934	4760.54	2006.07	947.512	1806.96	49.9612
44933	4766	1997.58	953.865	1814.56	49.9512
44932	4760.2	2003.54	953.169	1803.48	49.9567
44931	4766.78	2009.57	958.178	1799.02	49.9588
44930	4775.78	2014.23	953.713	1807.84	49.9621
44929	4803.49	2026.52	946.01	1830.96	49.9582
44928	4866.56	2016.08	959.529	1890.95	49.9615
44927	4775.79	1995.26	965.529	1815	49.9479

Fig. 9 Screenshot of the active power-live data collected in the data logger

V. CONCLUSION

This paper presents the progress of the proposed autonomous DR system development. The first phase of the work has been conducted and the system is well tested in terms of its responsiveness and accuracy. The utilization of IoT principle is also emphasized.

The Raspberry Pi3 board is able to serve the system as a controller as well as a data logger. The next phase of the work is to develop appropriate algorithm and program so that the

system is able to manage the loading according to DSM approach.

Acknowledgement

The authors are grateful for the grant provided by Kemenristek Dikti, The Republic of Indonesia through the Decentralization Competitive Research Scheme project 2016.

REFERENCES

- [1] Y. Shimomura, Y. Nemoto, F. Akasaka, R. Chiba, and K. Kimita, "A method for designing customer-oriented demand response aggregation service," *CIRP Ann – Manuf Technol*, vol. 63, 2014, pp. 413–6.
- [2] F. Shariatzadeh, P. Mandal, and A.K. Srivastava, "Demand response for sustainable energy systems: A review, application and implementation strategy," *Renewable and Sustainable Energy Reviews*, vol. 45, 2015, pp. 343-350. Eason, B. Noble, and I.N. Sneddon, "On certain integrals of Lipschitz-Hankel type involving products of Bessel functions,"
- [3] M.H. Albadi and E.F. El-Saadany, "A summary of demand response in electricity markets," *Electr. Power Syst Res*, vol. 78, 2008, pp. 1989-96.
- [4] C.W. Gellings and M. Samotyj, "Smart grid as advanced technology enabler of demand response," *Energy Effic*, vol. 6, 2013, pp. 685-94.
- [5] N. O'Connell, P. Pinson, H. Madsen and M. O'malley, "Benefits and challenges of electrical demand response: a critical review," *Renew Sustain Energy Rev*, vol. 39, 2014, pp. 686-99.
- [6] H.T. Haider, O.H. See and W. Elmenreich, "A review of residential demand response of smart grid. *Renew and Sustain Energy Reviews*, vol. 59, 2016, pp. 166-178.
- [7] C.O. Adika and L. Wang, "Smart charging and appliance scheduling approaches to demand side management," *Int J Electr Power Energy Syst*, vol. 57, 2014, pp. 232-40.
- [8] Y. Xiao, "Communication and networking in smart grids. Boca Raton, FL: CRC Press, 2012.
- [9] X.H. Li and S.H. Hong, "User-expected price-based demand response algorithm for a-home-to-grid system," *Energy*, vol. 64, 2014, pp. 437-49.
- [10] S. Gyamfi, S. Krumdieck and T. Urmee, " Residential peak electricity demand response-highlights of some behavioural issues," *Renew Sustain Energy Rev*, vol. 25, 2013, pp. 71-7.
- [11] V. Hamidi, F. Li and F. Robinson, "Demand response in the UK's domestic sector," *Electr Power Syst Res*, vol. 79, 2009, pp. 1722-6.
- [12] S. Faharani, M. Tabar and H. Tourang, "Using exponential modeling for DLC Demand response programs in electricity markets," *Res J Appl Sci Eng Technol*, vol. 4, 2012, pp. 749-53.
- [13] D. Jang, J. Eom, M.G. Kim, and J.J. Rho, "Demand responses of Korean commercial and industrial businesses to critical peak pricing of electricity. *JCleanProd*, vol. 90, 2015, pp. 275–90.
- [14] W. Meng, R. Ma, and H.H. Chen, "Smart grid neighborhood area networks: a survey," *IEEE Netw*, vol 28, 2014, pp. 24–32.
- [15] A.I. Sabbah, A. El Mougy and M. Ibnkahla, "A survey of networking challenges and routing protocols in smart grids," *IEEE Trans Ind Inform*, vol. 10, 2014, pp. 210–21.
- [16] D. Miorandi, S. Sicari, F. De Pellegrini, and I. Chlamtac, "Internet of things: vision, applications and research challenges," *AdHoc Networks*, vol. 10, 2012, pp. 1497–516.
- [17] O. Vermesan and P. Friss P, "Internet of Things: Converging Technologies for Smart Environments and Integrated Ecosystems," River Publishers 2013.
- [18] IoT Tech, How IoT is set to work for demand response use cases. Feb-2016.
- [19] R.H. Jacobsen and S.A. Mikkelsen, "Infrastructure for intelligent automation services in the smart grid," *Wirel Pers Commun*, vol. 76, 2014, pp. 125–47.
- [20] S.D.T. Kelly, N.K. Suryadevara and S.C. Mukhopadhyay, "Towards the implementation of IoT for environmental condition monitoring in homes," *IEEE Sens J*, vol. 13, 2013, pp. 3846–53.
- [21] V. Altmann, J. Skodzik, F. Golatowski and D. Timmermann, "Investigation of the use of embedded web services in smart metering applications," *IECON2012-38th annual conference on IEEE industrial electronics society*, 2012, pp. 6172–7.
- [22] S. Mohanty, "Implementation of a web of things based smart grid to remotely monitor and control renewable energy sources," In: *Proceedings of 2014 IEEE students' conference on electrical electronics and computer science*, 2014, pp. 1–5.
- [23] J. Lloret, E. Macias, A. Suárez and R. Lacuesta, "Ubiquitous monitoring of electrical household appliances," *Sensors*, vol. 12, 2012, pp. 15159–91.
- [24] A. Vergnaud, J.P. Fasquel, L. Autrique, "Python based internet tools in control education," *IFAC-Papers Online*, vol. 48 (29), 2015, pp. 43-48.
- [25] <http://pages.jh.edu/~pfleming/compbio/files/byte/ch01s02.html>, Retrieved on 31 July 2016.
- [26] Á. Hoyo J.L. J.L. Guzmán, J.C. Moreno, and M. Berenguel, "Teaching Control Engineering Concepts using Open Source tools on a Raspberry Pi board," *IFAC-Papers Online*, vol. 48(29), 2015, pp. 99-104.