

print ISSN: 2234-8255  
online ISSN: 2234-8883

# JICCE

Journal of information and  
communication convergence engineering  
<http://jicce.org>

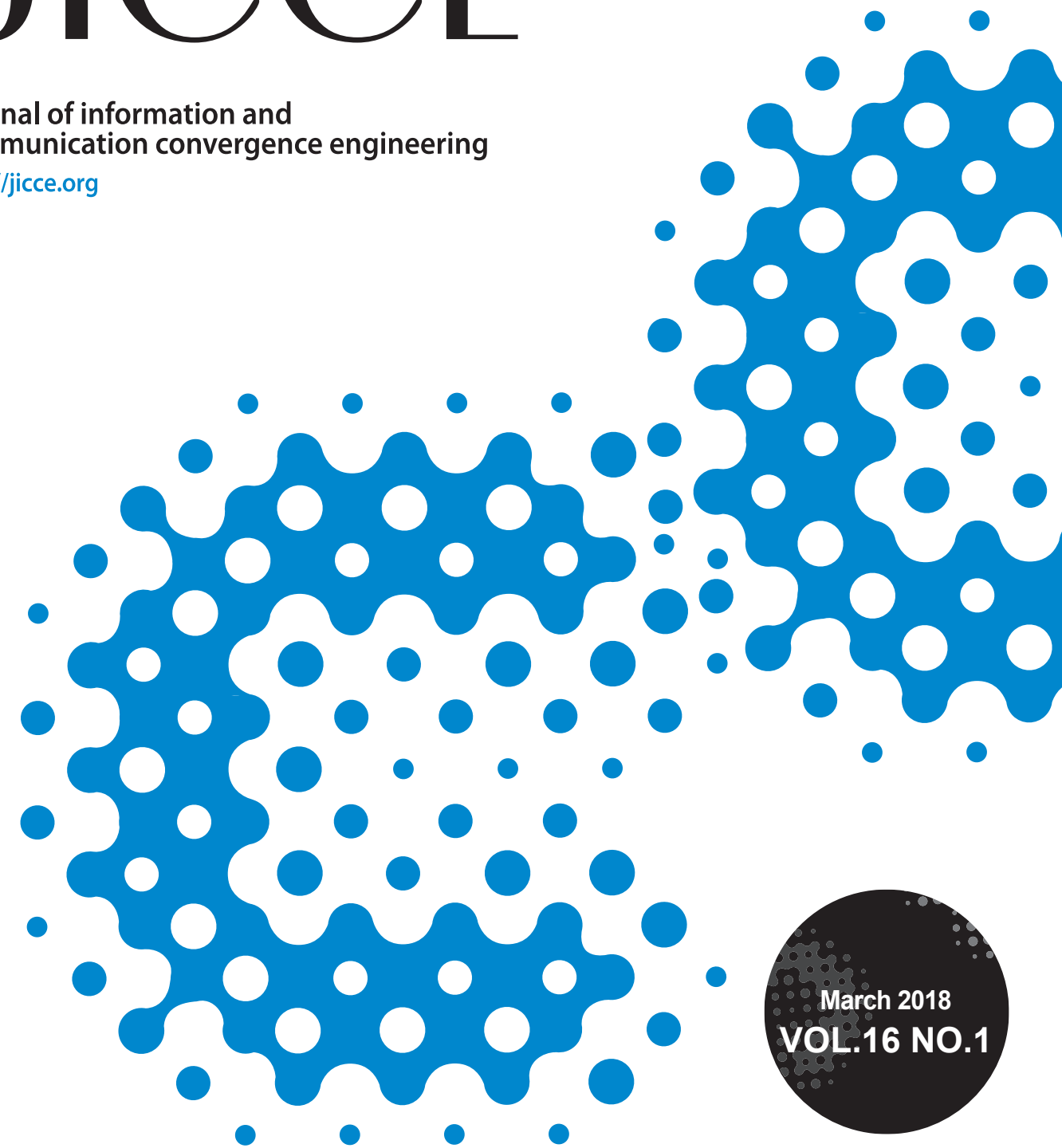

March 2018  
VOL.16 NO.1

JICCE Journal of information and communication convergence engineering

Vol. 16 No. 1 March 2018 pp. 1-65

KIICE

JICCE  
Journal of information and  
communication convergence engineering  
<http://jicce.org>

print ISSN: 2234-8255  
online ISSN: 2234-8883  
<http://jicce.org>

# JICCE

Journal of information and  
communication convergence engineering

## Aims and Scope

Journal of Information and Communication Convergence Engineering (J. Inf. Commun. Converg. Eng., JICCE) is an official English journal of the Korea Institute of Information and Communication Engineering (KIICE). It is an international, peer reviewed, and open access journal that is published quarterly in March, June, September, and December. Its objective is to provide rapid publications of original and significant contributions and it covers all areas related to information and communication convergence engineering including the following areas: Communication System and Applications, Networking and Services, Intelligent Information System, Multimedia/Digital Convergence, Semiconductors and Communication Devices, Imaging and Biomedical Engineering, Computer vision and Autonomous Vehicles.

Full text PDF files and XML are also available at the official website (<http://www.jicce.org>)

## Background

It has been published since 2003 with a title of International Journal of Maritime Information and Communication Sciences. In 2012, this journal was greatly reformed to further improve the quality of journal, for example, title, research areas and policy of journal etc. The title was changed from the year of 2012 as Journal of Information and Communication Convergence Engineering.

## Subscription

JICCE is not for sale, but is freely distributed to members of the Korea Institute of Information and Communication Engineering and relevant institutions. Circulation number of print copies is 800. Individuals or Institutions, who wish to subscribe this journal, please contact the editorial office through mail ([kiice@kiice.org](mailto:kiice@kiice.org)).

All or part of JICCE is indexed/covered by Google Scholar, Korea Citation Index (KCI), DBpia, KSCI, CrossRef, KoreaScience, and OAK.

## Volume 16 Number 1 March 2018

---

Published on 31 March 2018

Published by The Korea Institute of Information and Communication Engineering

### Editorial Office (Manuscript Editing)

Editor-in-Chief Yun Seop Yu, Ph. D.

Department of Electrical, Electronic & Control Engineering, Hankyong National University  
327, Jungang-ro, Anseong-si, Gyeonggi-do, 456-749, Korea

Tel: +82-31-670-5293 Fax: +82-31-670-5299 e-mail: [ysyu@hknu.ac.kr](mailto:ysyu@hknu.ac.kr)

### Editorial and Publishing Office

The Korea Institute of Information and Communication Engineering  
#1802, Yuwon-officetel, Seomyeonmunhwa-ro, Busanjin-gu, Busan 614-731, Korea

Tel: +82-51-463-3683 Fax: +82-51-464-3683 <http://www.kiice.org/>

e-mail: [kiice@kiice.org](mailto:kiice@kiice.org) e-submission: <http://jicce.org>

### Printing Office

Hanrimwon Co., Ltd.

13F Toegyero 20, 51 Gil, Jung-gu, Seoul 04559, Korea

Tel: +82-70-7865-4287 Fax: +82-2-2179-9083 e-mail: [bflorist@hanrimwon.com](mailto:bflorist@hanrimwon.com)

## Copyright © The Korea Institute of Information and Communication Engineering

---

© It is identical to the 'Creative Commons Attribution Non-Commercial License' (<http://creativecommons.org/licenses/by-nc/3.0/>)

☞ This paper meets the requirements of KS Q ISO 9001:2009 / ISO 9001:2008 (Permanence of Paper).

---

This journal is supported by the Korean Federation of Science and Technology Societies.

## Editorial Board

### Editors

<b>Editor-in-Chief(EIC)</b>	<b>Yun Seop Yu (Since 2017)</b>	Hankyong National University, Korea
<b>Communication System and Applications</b>	<b>Hyun-Ho Choi</b>	Hankyong National University, Korea
<b>Networking and Services</b>	<b>Kyoung-Jae Lee</b>	Hanbat National University, Korea
<b>Intelligent Information System</b>	<b>Srikanta Patnaik</b>	SOA University & I.I.M.T., India
<b>Multimedia/Digital Convergence</b>	<b>Piet Kommers</b>	University of Twente, Netherlands
<b>Semiconductors and Communication Devices</b>	<b>Manuel Martinez-Corral</b>	University of Valencia, Spain
<b>Imaging and Biomedical Engineering</b>	<b>Mingui Sun</b>	University of Pittsburgh, USA
<b>Computer vision and Autonomous Vehicles</b>	<b>Reinhard Klette</b>	Auckland University of Technology, New Zealand

### Associate Editors

<b>Communication System and Applications</b>	<b>Walid Abdallah</b>	Military aviation school of Borj Elamri, Tunisia
	<b>NGUYEN XUAN SAM</b>	Posts and Telecoms Institute of Technology, Vietnam
	<b>Jeongwook Seo</b>	Namseoul University, Korea
	<b>Yang-Ick Joo</b>	Korea Maritime and Ocean University, Korea
<b>Networking and Services</b>	<b>Chung-Huang Yang</b>	National Kaohsiung Normal University, Taiwan
	<b>Kyeong Hur</b>	Gyeongin National University of Education, Korea
	<b>Kisong Lee</b>	Chungbuk National University, Korea
	<b>Jong-Wook Jang</b>	Dong-eui University, Korea
<b>Intelligent Information System</b>	<b>Hee-hyol Lee</b>	Waseda University, Japan
	<b>Lei Li</b>	Hosei University, Japan
	<b>Yingmin Jia</b>	Beihang University, China
	<b>Du Junping</b>	Beijing University of Posts and Telecomm, China
	<b>Changji Wang</b>	Sun Yat-Sen University, China
	<b>Kwang Baek Kim</b>	Silla University, Korea
	<b>Hwajeong Seo</b>	Hansung University, Korea

<b>Multimedia/Digital Convergence</b>	<b>Pedro Isaias</b>	The University of Queensland, Australia
	<b>Daehee Kim</b>	Soonchunhyang University, Korea
	<b>Hoekyoung Jung</b>	Pai Chai University, Korea
	<b>Doo Heon Song</b>	Yong-in SongDam College, Korea
<b>Semiconductors and Communication Devices</b>	<b>Sung Kyu Lim</b>	Georgia Institute of Technology, USA
	<b>Chang Y. Choo</b>	San Jose State University, USA
	<b>Natalia Korobova</b>	National Research University MIET, Russia
	<b>Deepti Gaur</b>	ITM University, India
	<b>Arun Anand</b>	Maharaja Sayajirao University of Baroda, India
	<b>Myung-jin Cho</b>	Hankyong National University, Korea
	<b>Bum Ho Choi</b>	Korea Institute of Industrial Technology, Korea
<b>Imaging and Biomedical Engineering</b>	<b>Tony Sahama</b>	Queensland University of Technology, Australia
	<b>Tayfun Akgul</b>	Istanbul Technical University, Turkey
	<b>Hiroshi Yoshikawa</b>	Nihon University, Japan
	<b>Zungho Zun</b>	George Washington University, USA
	<b>Genaro Saavedra</b>	University of Valencia, Spain
	<b>Sungeun Kim</b>	State University of New York, USA
<b>Computer Vision and Autonomous Vehicles</b>	<b>Chia-Yen Chen</b>	University of Auckland, New Zealand
	<b>Mahdi Rezaei</b>	Islamic Azad University, Iran
	<b>Yanyan Xu</b>	MIT, USA
	<b>Fay Huang</b>	National Ilan University, Taiwan
	<b>Domingo Mery</b>	Universidad Catolica de Chile, Chile
	<b>Anko Boerner</b>	German Aerospace Center (DLR), Germany
	<b>Zhixun Su</b>	Dalian University of Technology, China

### Communication System and Applications

- 1**      **Nonlinear Compensation Using Artificial Neural Network in Radio-over-Fiber System**  
Andres C. Najarro<sup>1</sup> and Sung-Man Kim
  
- 6**      **A New Technique for Localization Using the Nearest Anchor-Centroid Pair Based on LQI Sphere in WSN**  
Sagun Subedi and Sangil Lee
  
- 12**     **10-GHz Band Voltage Controlled Oscillator (VCO) MMIC for Motion Detecting Sensors**  
Sung-Chan Kim, Yong-Hwan Kim, and Keun-Kwan Ryu
  
- 17**     **Alternating-Projection-Based Channel Estimation for Multicell Massive MIMO Systems**  
Yi Liang Chen, Rong Ran, and Hayoung Oh
  
- 23**     **Implementation of Spectrum-Sensing for Cognitive Radio Using USRP with GNU Radio and a Cloud Server**  
Huynh Thanh Thien, Rene Tendeng, Hiep Vu-Van, and Insoo Koo

### Networking and Services

- 31**     **Capacity Design of a Gateway Router for Smart Farms**  
Hoon Lee
  
- 38**     **Measurement Allocation by Shapley Value in Wireless Sensor Networks**  
Sang-Seon Byun

### Semiconductors and Communication Devices

- 43**     **Analysis of Flat-Band-Voltage Dependent Breakdown Voltage for 10 nm Double Gate MOSFET**  
Hakkee Jung and Sima Dimitrijevic

## **Multimedia/DigitalConvergence**

- 48**    **Keyword Analysis Based Document Compression System**  
Kerang Cao, Jongwon Lee, and Hoekyung Jung

## **Intelligent Information System**

- 52**    **Odoo Data Mining Module Using Market Basket Analysis**  
Yulia, Gregorius Satia Budhi, and Stefani Natalia Hendratha

## **Computer Vision and Autonomous Vehicles**

- 60**    **Smart Home System Using Internet of Things**  
Leo Willyanto Santoso, Resmana Lim, and Kevin Trisnajaya



# Smart Home System Using Internet of Things

Leo Willyanto Santoso<sup>1\*</sup>, Resmana Lim<sup>2</sup>, and Kevin Trisnajaya<sup>1</sup>, *Member, KIICE*

<sup>1</sup>Department of Informatics, Petra Christian University, Surabaya 60236, Indonesia

<sup>2</sup>Department of Electrical Engineering, Petra Christian University, Surabaya 60236, Indonesia

## Abstract

The Internet of Things (IoT) is happening now. By implementing IoT, we can build smart home system. Smart home is an application that is a combination of technology and services that specialize in the home environment with specific functions aimed at improving the efficiency, comfort and security of the occupants. Smart homes filled with connected products are loaded with possibilities to make our lives easier, more convenient, and more comfortable. This intelligent home system uses a microcontroller to process functions that provided by smart home system, such functions as RFID for door access and PIR sensors for motion detection. By using Android users could control the sensors anytime and anywhere. Microcontroller used is Arduino IDE with WeMos D1R2 board. Based on the testing process, there was a successful communication between the components of the device, sensors, and Android devices. Users could open or close the solenoid, users can also turn off or turn on electronic devices using Android.

**Index Terms:** Automated home, Internet of Things (IoT), Microcontroller, Smart home

## I. INTRODUCTION

IoT or Internet of Things is a system whereby interrelated devices could exchange data over the Internet without requiring human-to-human or human-to-computer interaction [1]. Things in the IoT are like a sensor-mounted chair, a heart monitor implant, or a vehicle with a sensor installed to alert tire pressure. IoT use objects with sensors to record data. The data obtained will be processed through a processor board or microcontroller. Microcontroller commonly used for IoT is Raspberry Pi, Arduino, ESP8266, and others. People are now tend to invest in IoT by implementing several application [2]. One of the application of IoT is smart home system.

Smart home system (hereafter Smart Home) allows users to build and maintain a house that is smart enough to maintain energy levels and provide many applications automati-

cally. Smart Home will take advantage of its environment and allow for regular controls while users are not in or inside the home. So, the user could know that the house is performing well in terms of energy.

Smart Home is divided into several parts including Smart Home for door security and motion sensors. Security systems in homes are now sometimes easy to penetrate by using only a few tools. By implementing Smart Home on the security of the door then its security can be increased. Moreover, by equipping with a motion sensor, the smart home application could detect the human presence. The proposed system should able to control other electronic devices via the internet. The implementation of smart home system could be seen in Fig. 1.

In this paper, authors make a Smart Home application using microcontroller based on Android so users can feel safe and comfortable in the house.

Received 21 March 2018, Revised 23 March 2018, Accepted 26 March 2018

\*Corresponding Author Leo Willyanto Santoso (E-mail: [leow@petra.ac.id](mailto:leow@petra.ac.id), Tel: +62-312983455)  
Department of Informatics, Petra Christian University, Siwalankerto, Surabaya 60236, Indonesia

Open Access <https://doi.org/10.6109/jicce.2018.16.1.60>

print ISSN: 2234-8255 online ISSN: 2234-8883

© This is an Open Access article distributed under the terms of the Creative Commons Attribution Non-Commercial License (<http://creativecommons.org/licenses/by-nc/3.0/>) which permits unrestricted non-commercial use, distribution, and reproduction in any medium, provided the original work is properly cited.

Copyright © The Korea Institute of Information and Communication Engineering

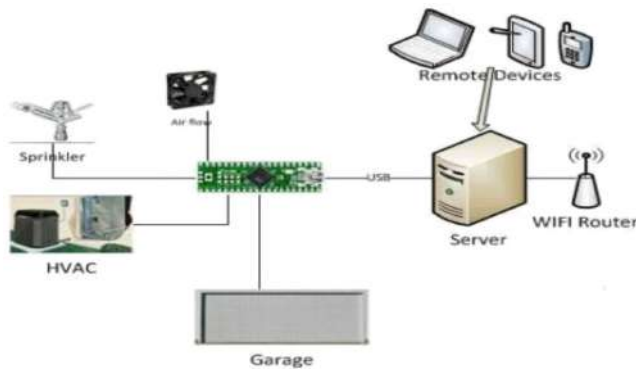

**Fig. 1.** The implementation of Smart Home system.

The main contributions of this paper are as follows. (1) The designed IoT system enables the communication among different smart devices, including smart phones, microcontroller, and sensors. (2) The system provides solution to improve the home security by using cutting edge technology.

The remaining part of this paper is organized as follows. Section II presents the background and the related work. Section III presents the design of the IoT system and Section IV present the testing of the proposed system. Finally, the conclusions are drawn in Section V.

## II. RELATED WORKS

In this section, the previous work of IoT, Ubidots, and microcontroller are presented.

### A. Internet of Things

The IoT is a technology that has become popular to describe the machine connectivity phenomenon [3-5]. Small sensors and computer chips are placed on a variety of devices or things, which enable them to communicate via the internet or other network to computer systems. As the IoT moves more into daily life, it creates exciting opportunities for developer and researcher alike [6]. In industry, IoT could do automation in the industrial processes [7]. IoT can be used for agricultural purposes [8]. IoT was illustrated by its typical use in medical system and smart home [9, 10].

### B. Ubidots

Ubidots is a server that can be used for the implementation of the Internet of Things. Ubidots helps for the process of cloud implementation. Ubidots provides APIs to help with the data collection process and make it informational. API is a way or solution for objects to interact with the web. This API allows makers to make changes and retrieval data

from the server. This API supports both HTTP and HTTPS usage. To exchange data required API key. To retrieve a value or variable from the server then required the ID of that variable and the user account tokens that the server has given. To facilitate Android developers, Ubidots has provided a library that works to shorten the writing of HTTP requests in Java [11]. Ubidots has been used in several IoT-based system, for example for health management system [12], smart home [13, 14] and for environmental monitoring system [15].

### C. Arduino IDE

Arduino IDE (Integrated Development Environment) is an open-source software that helps create scripts or code and upload the script or code on the board or microprocessor. Arduino IDE has an environment written in Java. The Arduino IDE also has a compiler for C or C++ languages. Arduino IDE does have a major function to help create scripts or code for various boards or microprocessors [16].

### D. Microcontroller

Microcontroller is a microprocessor that has additional parts that make it possible to organize or control other objects. It can be interpreted that the microcontroller run programs that have been created by the user and stored in memory. Microcontroller is a very useful tool that can help the designer to manipulate data obtained from input or output. Usually microcontroller is composed of microprocessor, memory and I/O. The microprocessor itself is composed of central processing unit (CPU) and control unit (CU). CPU is the main brain that performs arithmetic and logic processes. While CU controls the operation of the microprocessor and sends signals to other parts of the microprocessor to perform instructions [17].

## III. DESIGN AND IMPLEMENTATION

Block diagram and schematic design are used to explain how to assembly the device. The block diagram and schematic design can be seen in Fig. 2. The ESP8266 is an ease Wi-Fi chip with full TCP/IP stack and MCU (microcontroller unit) capacity. WeMos ESP8266 is associated with RFID to get data from ID tags that are already available, then switches are useful for arranging the connected solenoid with 12-V adapter and WeMos ESP8266. This is used to supply the power when ID tag in the scan match with the desired then solenoid will be electrified and open. Terminal is used to connect GND (ground) pin and 3.3-V pin to be used by RFID and Relay.

A passive infrared (PIR) sensor connected with WeMos



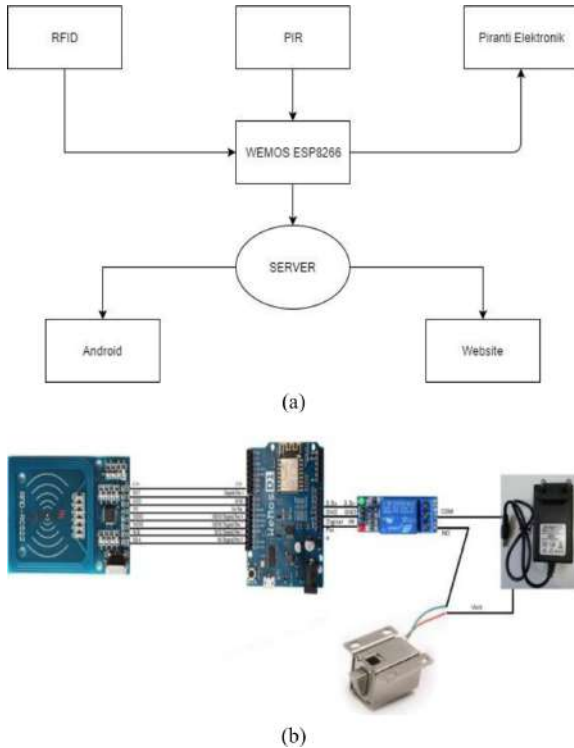
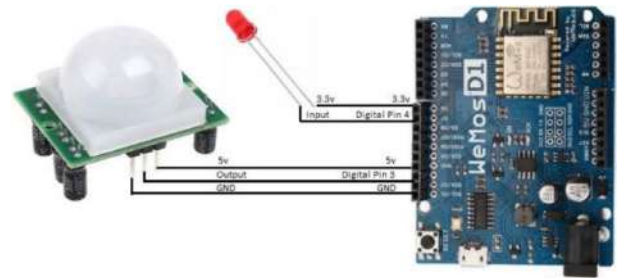

**Fig. 2.** The block diagram (a) and RFID schematic design (b).

ESP8266 and LED. A PIR sensor is an electronic sensor that measures infrared (IR) radiation being emitted from objects in its field-of-view. A PIR-based motion detector is used to sense movement of people, animals, or other objects. They are commonly used in burglar alarms and automatically-activated lighting systems. An individual PIR sensor detects changes in the amount of infrared radiation impinging upon it, which varies depending on the temperature and surface characteristics of the objects in front of the sensor. When an object, such as a human, passes in front of the background, such as a wall, the temperature at that point in the sensor’s field-of-view will rise from room temperature to body temperature, and then back again. The sensor converts the resulting change in the incoming infrared radiation into a change in the output voltage, and this triggers the detection. The picture can be seen in Fig. 3.

Database is used to store data both from server and from user input. The database is used to store user account information such as tokens and tags from RFID. The database relation used is shown in Fig. 4.

Arduino IDE was used to develop program for microcontroller. The open-source Arduino Software (IDE) makes it easy to write code and upload it to the board. It runs on Windows, Mac OS X, and Linux. The environment is written in Java and based on Processing and other open-source software. To interact with the sensor or server, we need to



**Fig. 3.** The PIR schematic design.

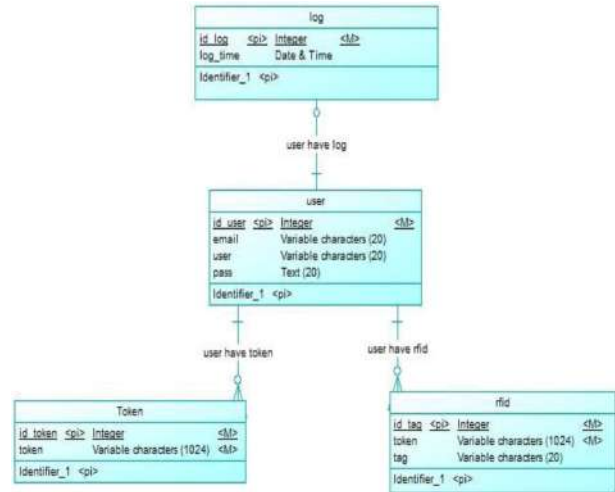

**Fig. 4.** The entity relationship diagram.

add the Library manually. To add the Library to the Arduino IDE, we must select Sketch and then select Include library.

The microcontroller program is divided into two parts, namely the setup part and the loop section. The setup part is the function that runs at the beginning of the microcontroller run, and the loop part is a function that runs continuously after the setup function is executed.

#### IV. TESTING AND DISCUSSION

This section discusses the system testing of the smart home system using IoT. System testing is done by doing the process. The purpose of system testing is to know whether the program can perform well and in accordance with the needs.

The sign in page is used for users who want to access the available sensors. The sign in page can be seen in Fig. 5. If the username and password are entered correctly, then the user will be moved to the main menu. After the user successfully logged in the user will be directed to the main menu that contains profile, sensor menu, and logout. Where the

profile contains the user information, the sensor menu contains the sensors that will be used and logout to exit the application.

This Sensor Menu page contains sensors that can be used by users, such as RFID sensors and electronic device sensors, which in which RFID serves to open the solenoid and the electronic device itself serves to turn off or turn on the lights. The interface of the sensor menu can be seen in Fig. 6.

When the user clicks on the RFID it will show a function of entry that is useful to open the solenoid, by changing the value from 0 to 1 or 1 to 0. This function use Blynk API and called Android using JSON.

After that if it has opened the solenoid, then the user can also turn on the lights and turn it off, in the same way that is



Fig. 5. The Login page.

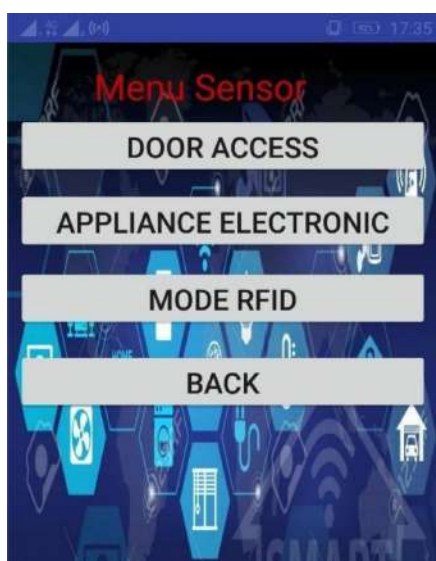

Fig. 6. The Sensor Menu page.

by changing the value from 0 to 1.

On the RFID management page, admin could manage and add a new RFID for the use of a new sensor. After entering the RFID manage page, the Admin can see some tags that have been stored in the database. To delete the tag, Admin could directly press the garbage button, where its function will directly delete the tag in the database. The RFID management page can be seen in Fig. 7.

In the user management page, devoted to admin that is useful to manage the user that is from start new user add, edit and delete. The manage user page can be seen in Fig. 8.

On this page, Admin could add user by pressing button plus and move page. Admin can also delete users by pressing the button illustrated junk, and immediately delete the user want to be deleted without the need to move pages.

In the Token Management page, Admin could add a new token for the use of a new sensor. The Manage Token page



Fig. 7. The RFID Management Tag page.

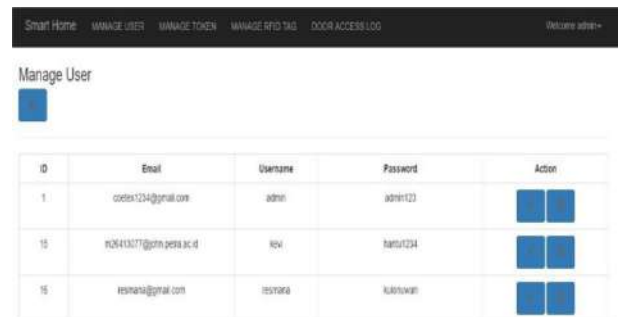

Fig. 8. The User Management page.

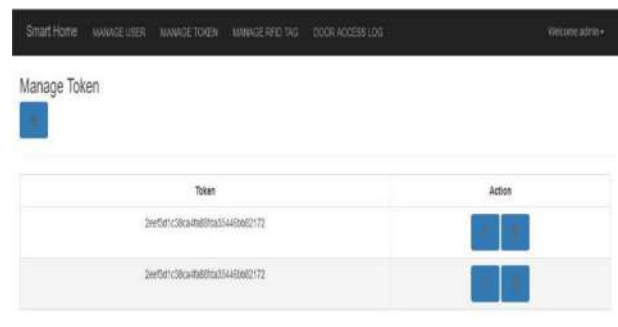

Fig. 9. The Token Management page.

can be seen in Fig. 9.

After entering the manage token page, admins can see some tokens that have been stored in the database, then admin can also add a new token by pressing the image plus the top left. Admin can also edit the same way by simply pressing the pencil button. Moreover, admin could also delete token, and the function immediately runs without having to move the page again.

## V. CONCLUSION

Improvement of the security level at home is a major challenge in the country like Indonesia, the technological improvement is a mandatory work for this issue. We propose a novel technology by means of which gathered data from physical sensing devices is mitigated in the cloud server to produce the current state of the environment.

The IoT based architecture meet the real-time monitoring to the home situation of the people, and remote control of household equipment through the network, has the security alarm, remote control, remote environmental monitoring and other functions, and has certain practical significance.

The sensors and microcontroller are successfully interfaced with the cloud server. The data is stored successfully in the database and can be accessed remotely via Android devices. All observations and experimental set up proves that this is a complete solution for smart home system. User can have access to the data from electronic devices and doors, and they are able to monitor the condition and situation in the home. Implementing this system will enhance the quality of live by improve the security aspect.

The system can further been improved by incorporating new self-learning techniques which could deployed in the cloud to understand the behavior of the sensing data and can take autonomous decisions.

## REFERENCES

[ 1 ] A. McEwen and H. Cassimally, *Designing the Internet of Things*. Chichester: John Wiley & Sons, 2014.  
 [ 2 ] L. W. Santoso and Yulia, "Analysis of the impact of information technology investments: a survey of Indonesian Universities," *ARPJN Journal of Engineering and Applied Sciences*, vol. 9, no. 12, pp. 2404–2410, 2014.

[ 3 ] J. Tan and S. G. M. Koo, "A survey of technologies in internet of things," in *Proceeding of IEEE International Conference on Distributed Computing in Sensor Systems*, Marina Del Rey, CA, pp. 269–274, 2014. DOI: 10.1109/DCOSS.2014.45.  
 [ 4 ] K. A. Al Rabaie and S. Harous, "Internet of Things: applications and challenges," in *Proceeding of the 12th International Conference on Innovations in Information Technology*, Al-Ali, UAE, pp. 1–6, 2016. DOI: 10.1109/INNOVATIONS.2016.7880054.  
 [ 5 ] S. Agrawal and M. Lal Das, "Internet of Things: a paradigm shift of future internet applications," in *Proceeding of the Nirma University International Conference on Engineering*, Ahmedabad, India, pp. 1–7, 2011. DOI: 10.1109/NUIConE.2011.6153246.  
 [ 6 ] Y. Liu and G. Zhou, "Key technologies and applications of Internet of Things," in *Proceeding of International Conference on Intelligent Computation Technology and Automation*, Zhangjiajie, China, pp. 197–200, 2012. DOI: 10.1109/ICICTA.2012.56.  
 [ 7 ] L. D. Xu, W. He, and S. Li, "Internet of Things in industries: a survey," *IEEE Transactions on Industrial Informatics*, vol. 10, no. 4, pp. 2233–2243, 2014. DOI: 10.1109/TII.2014.2300753.  
 [ 8 ] S. A. Jaishetty and R. Patil, "IoT sensor network based approach for agricultural field monitoring and control," *International Journal of Research in Engineering and Technology*, vol. 5, no. 6, pp. 45–48, 2016. DOI: 10.15623/ijret.2016.0506009.  
 [ 9 ] D. Lu and T. Liu, "The application of IoT in medical system," in *Proceeding of International Symposium on IT in Medicine and Education*, Guangzhou, China, pp. 272–275, 2011. DOI: 10.1109/ITIIME.2011.6130831.  
 [10] K. Ullah, M. A. Shah, and S. Zhang, "Effective ways to use Internet of Things in the field of medical and smart health care," in *Proceeding of International Conference on Intelligent Systems Engineering*, Islamabad, Pakistan, pp. 372–379, 2016. DOI: 10.1109/INTELSE.2016.7475151.  
 [11] Ubidots, "REST API Reference," [Internet], Available: <https://ubidots.com/docs/api/#what-is-a-restful-api>.  
 [12] S. Siddagangaiah, "A novel approach to IoT based plant health monitoring system," *International Research Journal of Engineering and Technology*, vol. 3, no. 11, pp. 880–886, 2016.  
 [13] D. V. S. C. Babu and A. L. Siridhara, "Energy efficient home automation system," *International Journal for Scientific Research & Development*, vol. 4, no. 4, pp. 596–599, 2016.  
 [14] D. Wang, D. Lo, J. Bhimani, and K. Sugiura, "AnyControl: IoT based home appliances monitoring and controlling," in *Proceedings of IEEE 39th Annual Computer Software and Applications Conference*, Taichung, Taichung, Taiwan, pp. 487–492, 2015. DOI: 10.1109/COMPSAC.2015.259.  
 [15] L. W. Santoso, A. Kwariawan, and R. Lim, "IoT for real time data logger and pH controller," in *Proceedings of the 2nd International Conference on Culture Technology*, Tokyo, Japan, 2017.  
 [16] Arduino Software (IDE) environment [Internet], Available: <https://www.arduino.cc/en/guide/environment>.  
 [17] D. Ibrahim, *Microcontroller-Based Temperature Monitoring and Control*. Oxford: Newnes, 2002.



**Leo Willyanto Santoso**

received his bachelor's degrees in computer science from Sepuluh Nopember Institute of Technology, Surabaya, Indonesia in 2002 and his master's degree in Information Technology from University of Melbourne, Australia, in 2007. He is currently an assistant professor at Informatics Department, Petra Christian University, Surabaya, Indonesia. His research interests include information system, intelligent system and big data analytics.



**Resmana Lim**

received his bachelor's degrees in electrical engineering from Petra Christian University, Surabaya, Indonesia in 1990 and his master's degree in Telecommunication Engineering from Asian Institute of Technology, Bangkok, Thailand, in 1994. He is currently an associate professor at Electrical Engineering Department, Petra Christian University, Surabaya, Indonesia. His research interests include IoT, intelligent system and computer vision.



**Kevin Trisnajaya**

received his bachelor's degrees in information technology from Petra Christian University, Surabaya, Indonesia in 2018. He is currently a junior software developer in Surabaya. His research interests include IoT and information system.



# Journal of Information and Communication Convergence Engineering



## COUNTRY

South Korea



Universities and research institutions in South Korea

## SUBJECT AREA AND CATEGORY

Computer Science  
Computer Networks and Communications  
Information Systems  
  
Engineering  
Electrical and Electronic Engineering  
Media Technology

## PUBLISHER

The Korean Institute of Information and Communication Engineering

## H-IND

6

Ad closed by Google

## PUBLICATION TYPE

Journals

## ISSN

22348255, 22348883

## COVERAGE

2017-2020

## INFOR

Home  
How to publish this journal  
ysyu@ac.kr

Ad closed by Google

SCC

Journal of Information and Communication Convergence Engineering (J. Inf. Commun. Converg. Eng., JICCE) is an official English journal of the Journal of Information and Communication Engineering (JICE). It is an international, peer reviewed, and open access journal published quarterly in March, June, September, and December. Its objective is to provide rapid publications of original and significant contributions and it covers all areas related to information and communication convergence engineering including the following areas: communication system and applications, networking and services, intelligent information system, multimedia and digital convergence, semiconductors and communication devices, imaging and biomedical engineering, and computer vision and autonomous vehicles.

Join the conversation about this journal

<p>Sovia Minyak Goreng Pouch [2000 mL]</p> <p><del>IDR 34k</del> <b>IDR 30k</b></p> <p><a href="#">BELI SEKARANG</a></p>	<p>Nutrilon Royal ProNutra 4 Madu Susu Formula Tin [800 g]</p> <p><b>IDR 155k</b></p> <p><a href="#">BELI SEKARANG</a></p>	<p>SMG/JOG/SOLO - Sparkle Handsoap Strawberry [375mL]</p> <p><b>IDR 10k</b></p> <p><a href="#">BELI SEKARANG</a></p>
--	--	--

Quartiles



FIND SIMILAR JOURNALS ?

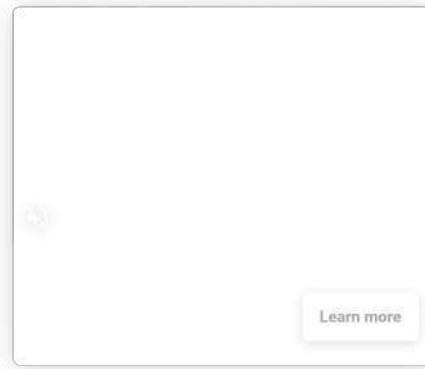

Learn more

1  
**Journal of Telecommunications and POL**

**44%**  
similarity

2  
**IEEE Access**  
USA

**44%**  
similarity

3  
**Future Internet**  
CHE

**41%**  
similarity

4  
**Journal of Comp Networks and EGY**

**39%**  
similarity

SJR

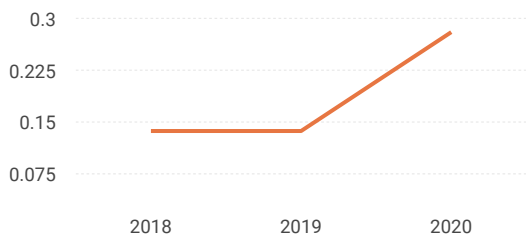

Total Documents

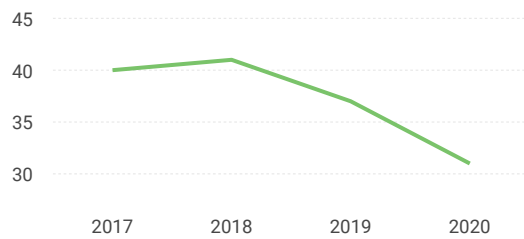

Total Cites Self-Cites

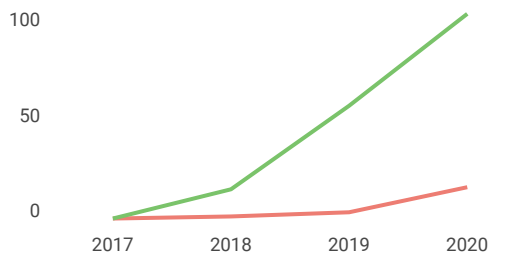

Citations per document

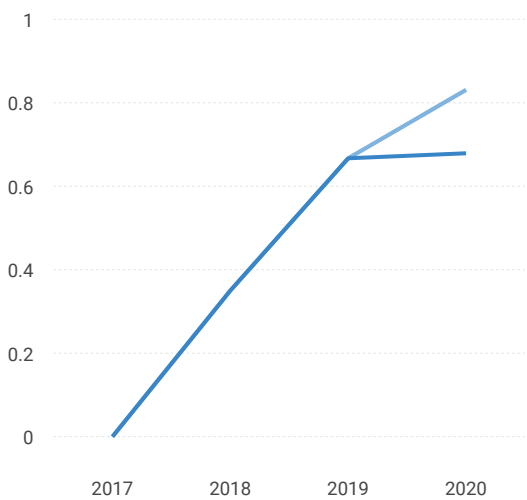

External Cites per Doc Cites per Doc

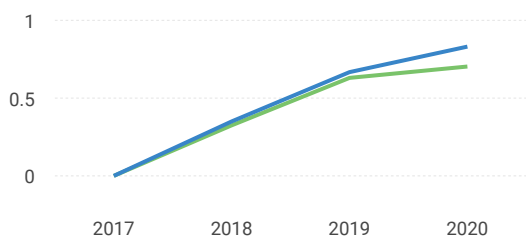

% International Collaboration

Citable documents

Non-citable documents

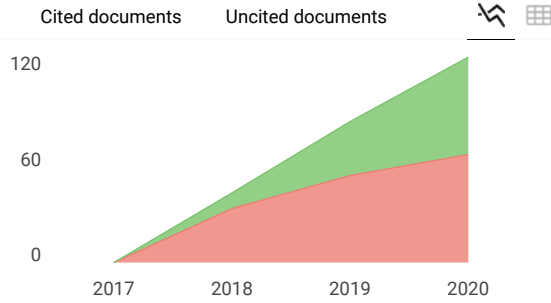
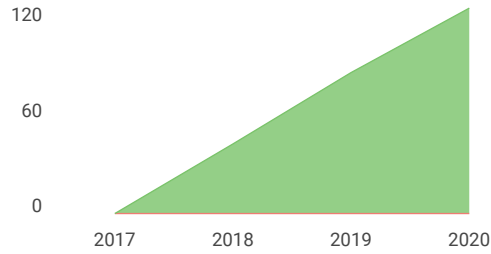
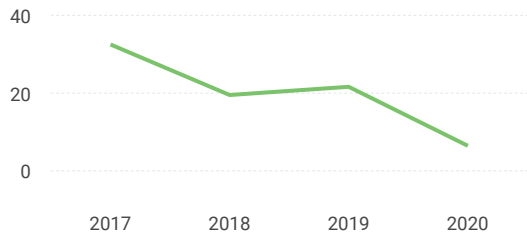

**Journal of Information and Communication...**

Q2    Media Technology

best quartile

SJR 2020  
0.28

powered by scimagojr.com

← Show this widget in your own website

Just copy the code below and paste within your html code:

```
<a href="https://www.scimaç
```

### SCImago Graphica

Explore, visually communicate and make sense of data with our **new free tool**.

Get it



Thanks for your feedback.

Ad choices ▶

Metrics based on Scopus® data as of April 2021

#### Leave a comment

Name

Email

(will not be published)



I'm not a robot  
reCAPTCHA  
Privacy - Terms

Submit

The users of Scimago Journal & Country Rank have the possibility to dialogue through comments linked to a specific journal. The purpose is to have a forum in which general doubts about the processes of publication in the journal, experiences and other issues derived from the publication of papers are resolved. For topics on particular articles, maintain the dialogue through the usual channels with your editor.

Developed by:



Powered by:

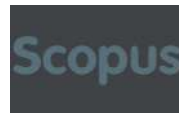

Follow us on @ScimagoJR

Scimago Lab, Copyright 2007-2020. Data Source: Scopus®

EST MODUS IN REBUS

Horatio (Satire 1, 1, 106)