

Effect of tilt angle of building-integrated wind turbine and photovoltaic façade on wind pressure and solar radiation

by Aris Budhiyanto

Submission date: 24-Jun-2020 02:35PM (UTC+0700)

Submission ID: 1348950560

File name: paper_conference_final.docx (6.77M)

Word count: 2143

Character count: 11177

Effect of tilt angle of building-integrated wind turbine and photovoltaic façade on wind pressure and solar radiation

Danny Santoso Mintonogo^a, Feny Elsiana^a, Aris Budhiyanto^{a*}

^a Architecture Department, Petra Christian University

Abstract

This study investigated the potential impacts of wind pressure and incident solar radiation on a building tilted façade installed with micro wind turbine and photovoltaic panels as a second skin façade for generating electricity. The wind pressure will affect wind turbine rotation and solar radiation will affect energy produced by the photovoltaic. The study used simulation modelling software to analyse the wind pressure and solar radiation received on the tilted façade. The research found that the pressure received by the tilted façade is larger than that received by the 90° tilted façade. The smaller the tilted angle of the façade, the more radiation received by the PV panel. Conversely, the larger tilted angle of the building façade, the less radiation received by the photovoltaic, despite the wind pressure received by the wind turbine being higher than that received by the 90° tilt façade. However, the more radiation received by the façade, the more heat received by the building.

Keywords: wind pressure, solar radiation, simulation, building facade

1. Introduction

Energy conservation has become a major concern around the world as buildings are built taller and consume more energy—about 30–40% of all primary energy is accounted for by buildings [1]. While fossil fuels are getting scarce and the price is unstable as well as the power generation from fossil fuels engenders environmental problems, the attempt to harness renewable energy, especially wind and solar energy is greatly improved [2]. Building-integrated photovoltaic (BIPV) as well as building-integrated wind turbine (BIWT) systems have been developed to serve that purpose.

The Bahrain World Trade Center is the first building integrated with three sets of turbines, each of which has a diameter of 29 m, and the Miami Cor Tower utilises wind energy by installing multiple horizontal wind turbine in four exterior walls at the top of the building [3]. BIWT can be applied on high-rise buildings as one or a few large-size wind turbines, or as many small-size wind turbines on the buildings instead of a few large-size wind turbines [4]. Installing many small-size wind turbines does not require any specific structural strengthening, but the total output power from this system would be considerably lower than that from large-size wind turbines because their installable area is limited to such areas as rooftops and edges of buildings and the diameter of the wind turbine is smaller. Therefore, to get enough electricity, a lot of wind turbines are needed. Installing a wind turbine on building façade should consider the shape of the buildings because it is a major determinant of airflow patterns around buildings and the wind flow is greatly dependent on the precise shape of the architecture [5,6].

The shape of the building affects not only the wind flow but also the incident solar radiation on the building façade, which is the main energy source for the BIPV system. PV panels have been developed to be installed as building elements, such as vertical claddings, windows and shading devices. However, to increase BIPV efficiency, the PV modules' direction and inclination angle need to be considered [7]. For example, in Singapore, an east-facing façade and panel slope of 30–40° is the most suitable location and inclination while in Indonesia, west-oriented PV panels with a 30° inclined angle generate more energy than PV panels facing other directions [8].

* Corresponding author
E-mail address: arisb@petra.ac.id

In this paper, an innovative building-integrated wind turbine and photovoltaic and (BIWtPv) system is proposed as a second skin façade that not only produces electricity but also reduces heat received by the building. As a Savonius-type wind turbine is installed on the building, the wind pressure and solar radiation received by the PV installed on the second skin façade should be analysed.

2. Proposed Model

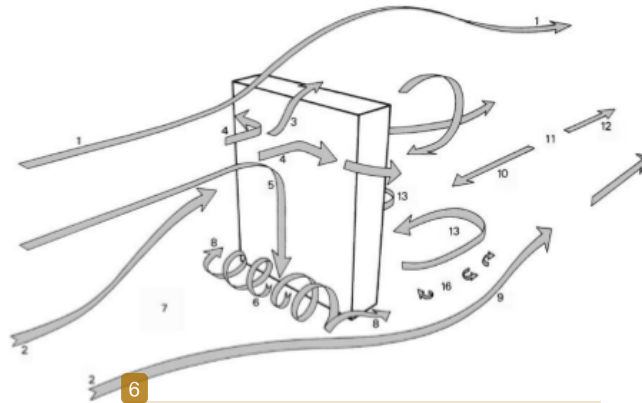

Figure 1. Wind flow pattern around a high-rise building [9]

Because the wind approaching a high-rise building is partly guided over the building, partly around the vertical edges, and partly deviated to the ground-level (Figure 1), a Savonius-type wind turbine is used. This is the simplest turbine and works due to the difference of forces exerted on each blade. The concave part of the wind flow catches the wind and forces the blade to rotate around its central vertical shaft. Otherwise, the convex part of the wind flow causes the blade to be deflected sideways around the shaft. Hence, concave blades with more drag force than the other half-cylinder will force the rotor to rotate [10]. In this proposed design, the Savonius wind turbine will be installed horizontally on the building façade to utilise the wind guided over the vertical façade of the building (Figure 2).

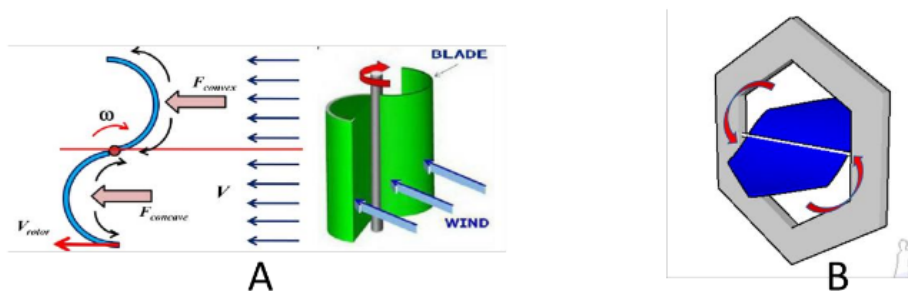

Figure 2. Savonius wind turbine (A) and wind turbine design installed on the building (B)

Instead of a large-size wind turbine, some small wind turbines and PV modules are installed on the second-skin façade. In a densely built city, high structures generate high wind turbulence and speed fluctuations, diverting the wind direction and potentially reducing its speed [11]; thus, installing small wind

turbines is more effective. The proposed model is shown in Figure 3. A second-skin façade integrated with a wind turbine and photovoltaic material is installed on the building façade to harness both wind and solar energy.

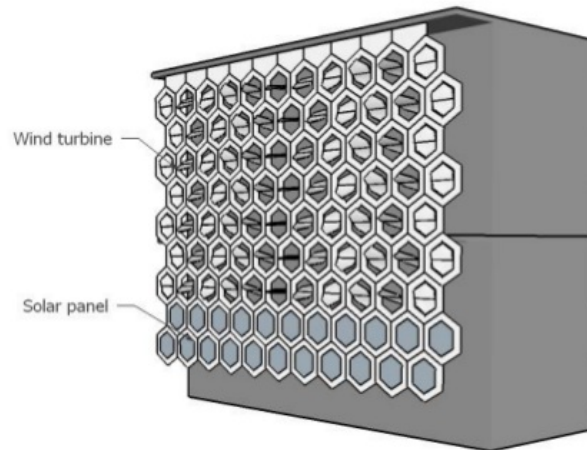

Figure 3. Proposed model of BIWtPv as second skin façade

3. Method

A simulation method was used in this study for calculating wind pressure and solar radiation received by the second-skin façade. A model of a BIWtPv as second-skin façade was set up within Flow Design and EnergyPlus simulation software. Flow Design, a CFD (Computational Fluid Dynamics) software, was used to simulate and visualise various design configurations of the fluid flow. It also can predict the airflow on cars and airplanes as well as on buildings [12]. EnergyPlus is a building energy simulation software developed by the United States Department of Energy [13] that can simulate cooling/heating loads, daylighting and photovoltaic systems with repeated accurate results that have been validated through analytical, comparative and empirical tests [14]. Flow Design software was used to analyse the wind pressure received by the façade while EnergyPlus was used to calculate the incident solar radiation.

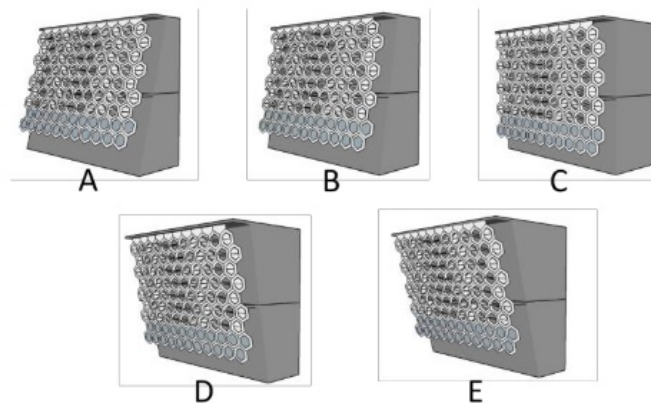

Figure 4. Tilted wall façade models at (A) 75°; (B) 80°; (C) 90°; (D) 100°; and (E) 105°

4. Result and discussion

Table 1. Wind velocity, wind pressure and pressure difference visualization

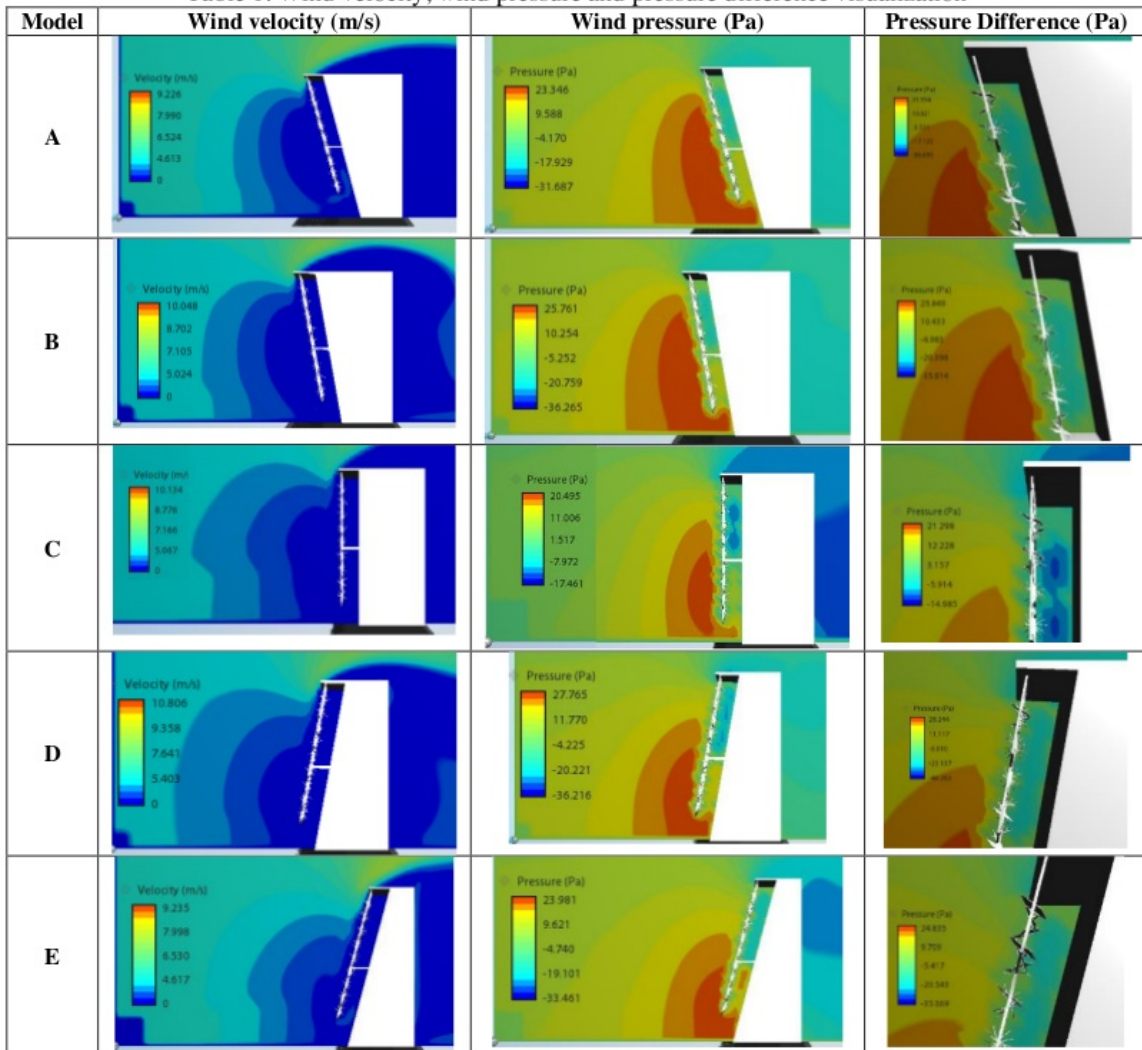

Table 2. Drag force, drag coefficient, pressure difference and wind speed

| Model | Drag Force (N) | Drag Coef. | Pressure Difference (Pa) | Wind Velocity (m/s) |
|-------|----------------|------------|--------------------------|---------------------|
| A | 1935.448 | 1.94 | 12 | 0-1 |
| B | 2089.775 | 1.97 | 10 | 0-1 |
| C | 1699.244 | 1.59 | 5 | 0-1 |
| D | 2213.338 | 2.02 | 16 | 0-1 |
| E | 1867.150 | 1.73 | 15 | 0-4 |

Tables 1 and 2 show the wind speed and wind pressure around the model. Of all models, the wind speed around the second-skin façade is the same at about 0–1 m/s, except in Model E, where the wind speed is around 0–4 m/s. Different from the wind speed, the wind pressure around the façade is different for all models. Among all models, the pressure difference of Model C is the smallest, indicating that 90° tilted second-skin façade is less effective for installing a wind turbine compared with the other tilted façades. There was no significant pressure difference between Models A and B. The same occurs between Models D and E despite the pressure on Models D and E being higher than on Models A and B. This indicates that a façade tilted at less than 90° is more effective.

Savonius wind turbine performance is based on the difference between the drag force that concerns the rotor surface and the amount drag force required to rotate the turbine shaft [15]. Among all models, the drag force and drag coefficients for Models B and D are higher than for the other models. This indicates that the potential of wind turbine rotation is higher than for the other models. On the contrary, the drag force and drag coefficient of Model C is the lowest, indicating that the wind turbine rotates less than in the other models. However, the higher drag force could result in damage to the building façade [12].

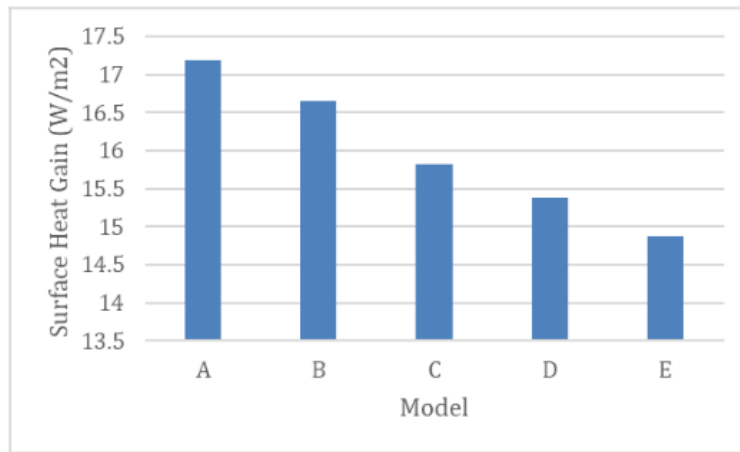

Figure 5. Solar incident radiation on second skin façade

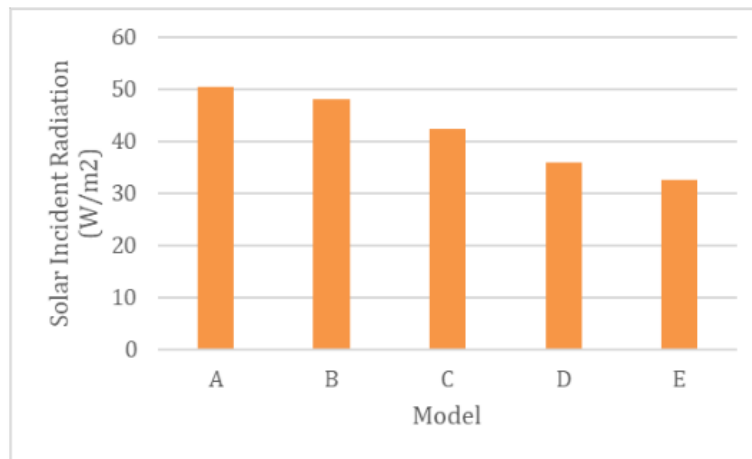

Figure 6. Surface heat gain on the east façade

Figure 5 shows solar radiation obtained on the second-skin façade. It is obvious that the higher the tilt angle of the wall, the smaller the solar radiation obtained. The highest solar radiation is obtained for Model

A (about 313.91 W/m²) while solar radiation obtained by Model E's façade is the lowest (about 202.22 W/m²). The higher the solar radiation, the more effective the PV panel in producing electricity. However, the more solar radiation received on the façade, the more the heat gain. Figure 6 shows the surface heat gain obtained on the walls of all models. As solar incident radiation on Model A is the highest, the surface heat gain on the façade is also the highest (over 50 W/m²).

5. Conclusion

In this paper, a second-skin façade integrated with a wind turbine and photovoltaic panels is analysed at different tilt angles. The study indicates that models with a tilted façade provide better performance for wind turbine installation than the 90° tilt angle façade model because the pressure difference around the façade is higher as well as the drag coefficient. However, a higher drag force could destroy the wind turbine installed on the building façade. Adding that the 75° tilted angle façade model received solar radiation higher than the other tilted façades and produced more electricity, the façade model with a 75° tilt angle produced more energy than the other models and the heat gain received by the building was larger than for the other models.

6. Acknowledgements

This research was supported by the Architecture Department of Petra Christian University and funded by The Ministry of Research, Technology and Higher Education of Indonesia.

References

- [1] J. Lee, J. Park, H. J. Jung, and J. Park, "Renewable energy potential by the application of a building integrated photovoltaic and wind turbine system in global urban areas," *Energies*, 2017; 10 (12).
- [2] W. T. Chong et al., "Performance investigation of a power augmented vertical axis wind turbine for urban high-rise application," *Renewable Energy*, 2013; 51, 388–397.
- [3] H. Zhou, Y. Lu, X. Liu, R. Chang, and B. Wang, "Harvesting wind energy in low-rise residential buildings: Design and optimization of building forms," *Journal of Cleaner Production*, 2108; 167, 306–316.
- [4] J. Park, H. J. Jung, S. W. Lee, and J. Park, "A new building-integrated wind turbine system utilizing the building," *Energies*, 2015; 8 (10), 11846–11870.
- [5] A. Bharat and A. S. Ahmed, "Effects of High Rise Building Complex on the Wind Flow Patterns on Surrounding Urban Pockets," *International Journal of Engineering Research and Development*, 2012; 4: 9, 21–26.
- [6] L. Kormaniková, H. Achten, M. Kopřiva, and S. Kmet', "Parametric wind design," *Frontier of Architectural Research*, 2018; 7: 3, 383–394.
- [7] D. S. Mintorogo, "Strategi Aplikasi Sel Surya (Photovoltaic Cells) Pada Perumahan Dan Bangunan Komersial," *Dimensi Teknik Arsitektur*, 2000; 28 (2), 129–141.
- [8] A. Budhiyanto, J. Suryabrata, and S. Saragih, "Study of Shading Device Building-Integrated Photovoltaic Performance on Energy Saving," *Journal of Urban and Environmental Engineering*, 2017; 11 (2), 202–207.
- [9] P. Moonen, T. Defraeye, V. Dorer, B. Blocken, and J. Carmeliet, "Urban Physics : Effect of the micro-climate on comfort , health and energy demand," *Frontier of Architectural Research*, 2012; 1 (3), 197–228.
- [10] F. Wenehenubun, A. Saputra, and H. Sutanto, "An experimental study on the performance of Savonius wind turbines related with the number of blades," *Energy Procedia*, 2015; 68, 297–304.
- [11] B. Loganathan, H. Chowdhury, I. Mustary, M. M. Rana, and F. Alam, "Design of a micro wind turbine and its economic feasibility study for residential power generation in built-up areas," *Energy Procedia*, 2019; 160, 812–819.
- [12] S. B. Amri and L. O. A. Syukur, "Analisis Aliran Angin Pada Atap Miring Melalui Uji Simulasi Flow Design," *Langkau Betang Jurnal Arsitektur*, 2017; 4 (2), 136-143.
- [13] D. B. Crawley, L. K. Lawrie, F. C. Winkelmann, and C. O. Pedersen, "EnergyPlus: New Capabilities in a Whole-Building Energy Simulation Program," *Building Simulation*, 2001; 51–58.

- [14] W. Pereira, A. Bögl, and T. Natschläger, "Sensitivity analysis and validation of an EnergyPlus model of a house in Upper Austria," *Energy Procedia*, 2014; 62, 472–481.
- [15] S. F. Pamungkas, D. S. Wijayanto, H. Saputro, and I. Widiastuti, "Performance 'S' Type Savonius Wind Turbine with Variation of Fin Addition on Blade," *IOP Conference Series: Materials Science and Engineering*, 2018; 288, 1-7.

Effect of tilt angle of building-integrated wind turbine and photovoltaic façade on wind pressure and solar radiation

ORIGINALITY REPORT

18%

SIMILARITY INDEX

12%

INTERNET SOURCES

14%

PUBLICATIONS

10%

STUDENT PAPERS

PRIMARY SOURCES

- 1 www.mdpi.com
Internet Source 4%
- 2 Ridwan, I Setyawan, Setiyono. "Performance of vertical axis Savonius wind turbines related to the fin number on the blade", IOP Conference Series: Materials Science and Engineering, 2019
Publication 3%
- 3 Poh Khai Ng, Nalanie Mithraratne, Harn Wei Kua. "Energy analysis of semi-transparent BIPV in Singapore buildings", Energy and Buildings, 2013
Publication 2%
- 4 Hong Zhou, Yujie Lu, Xiaodong Liu, Ruidong Chang, Bo Wang. "Harvesting wind energy in low-rise residential buildings: Design and optimization of building forms", Journal of Cleaner Production, 2017
Publication 2%
- 5 S F Pamungkas, D S Wijayanto, H Saputro, I Widiastuti. "Performance 'S' Type Savonius 1%

Wind Turbine with Variation of Fin Addition on Blade", IOP Conference Series: Materials Science and Engineering, 2018

Publication

| | | |
|----|---|-----|
| 6 | www.scipedia.com Internet Source | 1% |
| 7 | worldwidescience.org Internet Source | 1% |
| 8 | www.ijerd.com Internet Source | 1% |
| 9 | academypublication.com Internet Source | 1% |
| 10 | benthamopen.com Internet Source | 1% |
| 11 | Fan Yang, Mingyuan Gao, Jianli Cong, Ping Wang. "System dynamics modeling and experimental study of railway track with thermoelectric heater/generator in extreme weather conditions", Journal of Cleaner Production, 2020 Publication | <1% |
| 12 | Allegrini, Jonas, Viktor Dorer, and Jan Carmeliet. "Influence of the urban microclimate in street canyons on the energy demand for space cooling and heating of buildings", Energy and Buildings, 2012. Publication | <1% |

13

Submitted to Universiti Teknologi MARA

Student Paper

<1%

14

Submitted to Kingston University

Student Paper

<1%

Exclude quotes On

Exclude matches < 5 words

Exclude bibliography On